

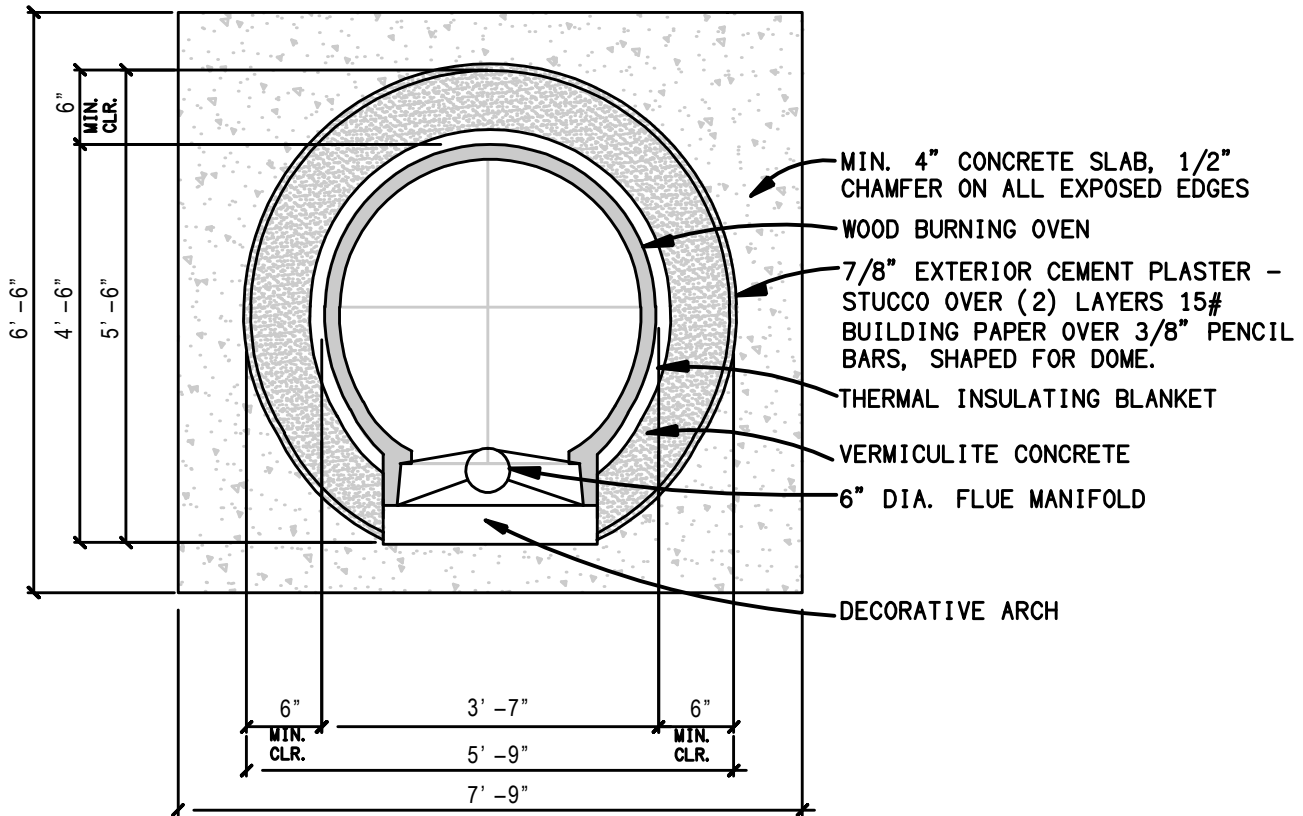

Oven Model 90

Mediterranean Assembly Plan
Plan View



BUILDING CODES VARY, CHECK WITH LOCAL BUILDING AND SAFETY DEPARTMENT FOR LOCAL REQUIREMENTS.

DIRECT VENT USING 6" LISTED CLASS "A" CHIMNEY AND CHIMNEY CAP W/ SPARK ARRESTOR

6" LISTED CHIMNEY PIPE, SIMPSON DOUBLE WALL CHIMNEY

7/8" EXTERIOR CEMENT PLASTER - STUCCO OVER STUCCO WIRE OVER PENCIL BARS

VERMICULITE CONCRETE

THERMAL INSULATING BLANKET

WOOD BURNING OVEN

2" INSULATING BASE

MIN. 4" CONCRETE SLAB W/ # 4 REBAR @ 12" O. C. EACH WAY

8" CONCRETE BLOCK, TYP.

HORIZ. #4 REBAR @ 16" O. C. MAX.

VERTICAL #4 REBAR @ 16" O. C. MAX.

7/8" EXTERIOR CEMENT PLASTER - STUCCO OVER STUCCO WIRE

4" CONCRETE SLAB W/ #4 BARS @ 16" O. C. EACH WAY

4" DRY SAND BASE

12" WIDE CONCRETE FOOTING W/ (2) #4 REBAR TOP & BOTTOM

UNDISTURBED OR COMPACTED EARTH

40" - 44"
VERIFY W/
OWNER

24 GA. G. I.
WEEP
SCREED

WOOD STORAGE

1' - 0"

1' - 0"

1' - 0"

Mediterranean Assembly Section



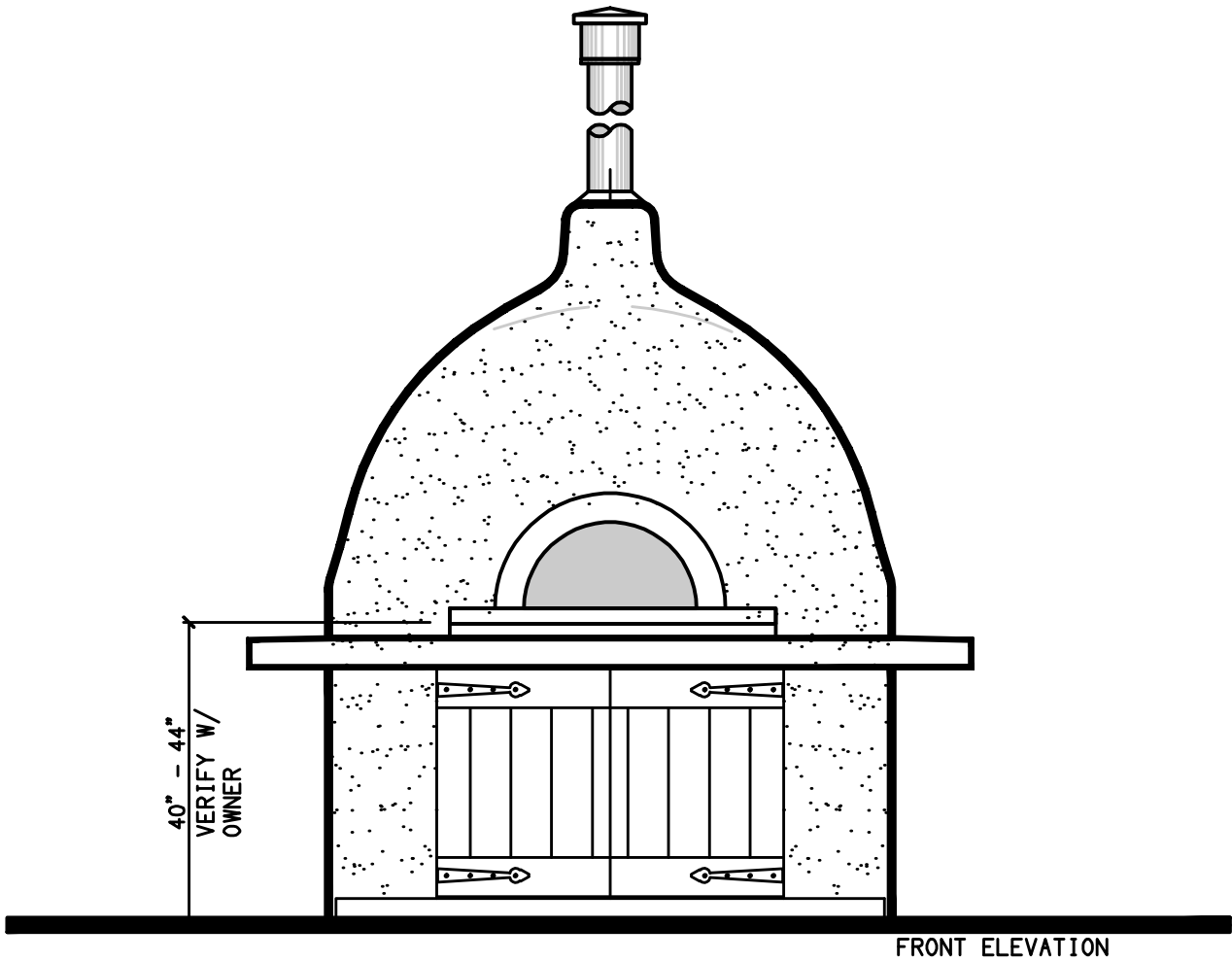

Mediterranean

